

# GENESIS™

*advanced cell technology*

## CD-2G, CD-5G, & CD-7G Installation & Operations Manual



## TABLE OF CONTENTS

### SECTION 1 General Information

1A. Description ..... 1  
 1B. Specifications ..... 1

### SECTION 2 Installation

2A. Location ..... 1  
 2B. Mounting ..... 1  
 2C. Electrical ..... 2  
 2D. Plumbing ..... 2

### SECTION 3 Operation

3A. Initial System Start-Up ..... 3  
 3B. Normal Operation ..... 3  
 3C. System Shut-Down ..... 3

### SECTION 4 Maintenance & Service

4A. System Electro-Mechanical Overview ..... 3  
 4B. PM Schedule ..... 4  
 4C. Troubleshooting ..... 4  
 4D. Contact Information ..... 5

### SECTION 5 Replacement Parts & Order Info

5A. Ordering Information ..... 5

Warranty ..... 6

### Appendix

Appendix "A" (Safety) ..... 7



**ALL Genesis™ CD Ozone Generators are NSF listed.**

## IMPORTANT SAFETY INSTRUCTIONS

### READ AND FOLLOW ALL INSTRUCTIONS.

- Read this manual completely before attempting installation.
- Risk of Electric Shock. Install the ozone unit and any metallic plumbing associated with the unit at least 5 ft from the inside wall of tub or pool, and no less than 1ft. above maximum water level.
- Risk of Electric Shock. Connect this ozone generator in accordance with the installation instructions. Do not install within an enclosure that would restrict ventilation.
- (Applicable to cord/plug connected units only) Risk of electric shock. Connect only to a properly grounded, grounding type receptacle.
- Do not bury cord.
- Warning – To reduce the risk of electric shock, replace damaged cord immediately.
- Follow all applicable electrical codes.
- Electric shock hazard. Be sure to turn power OFF at power source before any service work is performed. Failure to do so could result in serious injury or death.
- Warning – Short term inhalation of high concentrations of ozone and long term inhalation of low concentrations of ozone can cause serious harmful physiological effects. DO NOT inhale ozone gas produced by this device.
- For your safety, do not store or use gasoline, chemicals or other flammable liquids or vapors near this or any other appliance.
- A spontaneous and violent ignition may occur if oil, grease or greasy substances come in contact with oxygen under pressure. These substances must be kept away from oxygen regulators, cylinder valves tubing and connections, and all other oxygen equipment.

**SAVE THESE INSTRUCTIONS!**

## SECTION 1 General Information

### 1A. Description

The Genesis™ Corona Discharge series ozone generator described in this manual is designed to provide the benefits of ozonated water in an environmentally safe and effective manner. The high quality, specially engineered components ensure efficient ozone output and reliable performance.

The Genesis™ CD ozone generator is safe and harmless to your equipment if installed properly.

### 1B. Specifications

For detailed specifications refer to the ozone generator specification label located on the inside of the door on the unit.

Ozone Output:	CD-2G	CD-5G	CD-7G
Ozone output (+10%):	2 g/hr	5 g/hr	7 g/hr
Flow rate (max):	3 scfh	6 scfh	7 scfh
% weight O <sub>3</sub> :	2.5-3%	2-2.5%	3%

#### Power Requirements:

Domestic:	120 VAC 60Hz
Export:	230 VAC 50Hz
Overcurrent Protection:	10 A

#### Shipping Weight:

CD-2G	Approx. 50 lbs. / 23 kg.
CD-5G	Approx. 52 lbs. / 24 kg.
CD-7G	Approx. 61 lbs. / 27.5 kg.

#### Location Requirements\*:

Mounting:	Wall mount in a clean, protected area. Floor mounting kit optional.
Ambient Temp.:	40°F - 100°F (5°C - 38°C)
Ventilation:	Room should provide 6 air changes per hour minimum.
Clearance:	Provide a minimum of 4" clearance around unit.

\* Protection from weather elements must be provided for outdoor installations. Operating outside of the recommended temp. ranges may result in damage not covered under the manufacturer's warranty.

## SECTION 2 Installation

### 2A. Location

The CD-2G, CD-5G, & CD-7G are designed for wall mounting. **See Figure 1.** Mount generator in a clean, protected area, either indoors or outdoors. (See LOCATION REQUIREMENTS Section 1B) They can also be mounted to the floor or deck with optional feet. Locate generator out of reach of sprinklers or drainage spouts. Allow sufficient access for maintenance and all tubing and electrical wires. Generators must not be placed in locations where ambient ozone levels exceed 0.01 PPM.

### 2B. Mounting

#### 2B-1. Wall Mount Option

1. Attach the Wall Mounting Brackets to the base and top of the enclosure using four 1/4" x 1" long bolts and washers provided.
2. Refer to Figure 1. Mark the locations for the four mounting bolts and install anchors appropriate for the mounting surface.

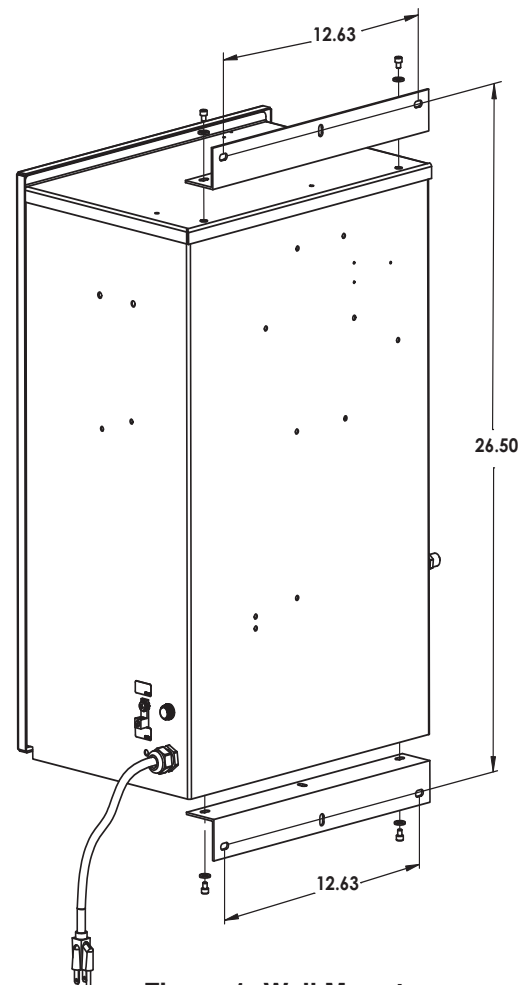

Figure 1: Wall Mount

3. Install the four mounting bolts through the Wall Mounting Brackets and into the anchors.

**2B-2. Floor Mount (optional)**

The enclosure can be floor mounted to a solid, flat surface using the optional Floor Mounting Kit Part Number 9-5004.

**2C. Electrical**

Refer to the unit's specification label and local electrical codes for information on proper electrical connection.

**2C-1. External Control**

Make sure that the control switch is properly rated for the ozone generator. A pair of control contacts is provided inside the ozone generator. Refer to wiring diagram and **Figure 4** for proper connection.

**2D. Plumbing**

Ozone gas is introduced to the circulation line using a venturi injector. Suction developed by the venturi allows the CD generator to operate safely under vacuum.

**2D-1. Injector Assembly**

Plumb the Injector and/or Degas Assembly into the water line according to the installation instructions for that assembly. **The Injector/Degas Assembly must be installed in the main return line after all other pool equipment.**

**2D-2. Water Check Valve (optional item)**

If the pool equipment is mounted above the water line, a 1/3# DELCheck check valve (P/N: CO-0101) must be installed between the pump outlet and the injector assembly.

**2D-3. Ozone Gas Line**

1. Install the ozone check valve (contained in parts bag) into the ozone output fitting on the generator. Apply Teflon tape, Mil T-27730A or equivalent, to threads. Flow direction is away from the generator. Install elbow or straight MPT-to-compression fitting (contained in parts bag) onto check valve. Insert one end of ozone tubing into the fitting, hold the tubing in place and tighten the fitting.

**NOTE: Use a back-up wrench when tightening all fittings.**

2. The injector assembly is also equipped with a compression fitting. Connect the other end of ozone tubing to the injector suction port as described in Step 1. **See Figure 2a.**

**NOTE: The ozone gas supply line must have a back flow prevention device (such as a check valve) installed between the ozone generator cabinet and the point of injection to prevent water from backing up into the generator system. An ozone supply check valve is included.**

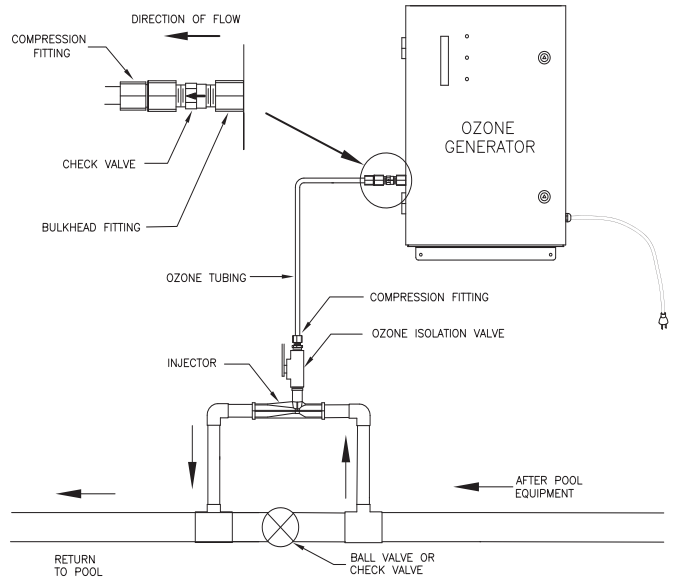

**Figure 2a: with Injector Assembly in Main Line**

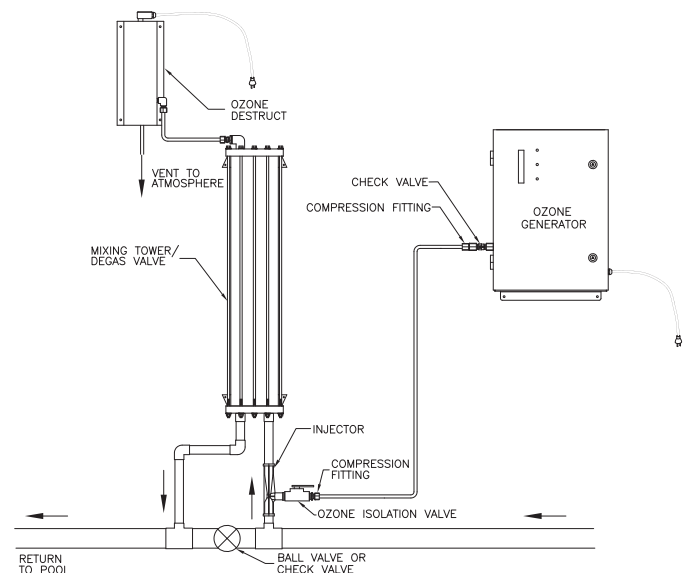

**Figure 2b: with DVX**

## SECTION 3 Operation

### 3A. Initial System Start-Up

Upon completing all of the generator system connections, you are ready to begin start-up procedures.

1. Check electrical fittings.
2. Check for proper voltage.
3. Turn on circulation pump.
4. Check for leaks.
5. With the ozone isolation valve closed, adjust injector bypass valve and/or filtration sidestream valve to flow water through the injector.
6. Open ozone isolation valve.
7. Turn ozone generator on.

**NOTE: If your Injector Assembly is equipped with a ball valve, close the valve by turning the handle clockwise until the proper suction is indicated as described in Section 3B.**

### 3B. Normal Operation

At this point, the system's cooling fans will start-up and the oxygen concentrator will begin operating. The green power indicator should be illuminated and the red vacuum indicator should turn off when sufficient vacuum is obtained. The green ozone indicator should then illuminate.

If the indicator lights are OK and the flowmeter is reading the proper flow (refer to specification label in unit), then the ozone generator is producing ozone and the injector assembly is injecting the ozone into the pool return/inlet line.

Make further adjustments to the injector bypass valve until vacuum light turns off and the ozone light turns on. **NOTE: Do not exceed the max air/oxygen flow rate specification as indicated on the specification sticker.**

If you experience complications, see TROUBLESHOOTING Section 4C or call 1-800-676-1335 for assistance.

### 3C. System Shut-Down

The following sequence of steps must be followed for servicing or for storage.

1. Unplug the ozone generator.
2. Close the ozone isolation valve on the ozone supply line.

**WARNING: Pool pump flow must not be shut-down when the ozone generator is operating. Doing so may cause water to back flow into the system and damage the generator module.**

## SECTION 4 Maintenance & Service

### 4A. System Electro-Mechanical Overview

*Refer to Figure 4* for component locations.

#### 4A-1. Indicator Lights

1. **Main Power:** Green light indicates that power is being supplied to the ozone generator. Compressor should be running.
2. **Ozone Power:** Green light indicates that power is being supplied to the high voltage Corona Discharge circuit and that ozone is being produced.
3. **Vacuum:** Red light indicates a vacuum fault. When sufficient suction is being supplied from the venturi injector, the red light will turn off.

#### 4A-2. Internal Components

1. **Corona Discharge (CD) Module:** The generator module consists of a high voltage electrode wrapped around a Teflon core inserted in a ceramic insulating tube. The assembly is encased in a thermally protected aluminum heat sink.
2. **Power Supply:** The fuse protected, self-regulated, high voltage/high frequency power supply provides the ideal electrical signal for efficient ozone production.
3. **Air Compressor:** Compressor produces and supplies compressed air to oxygen concentrator.
4. **Oxygen Concentrator:** Supplies concentrated, dry, oxygen feed gas to the ozone generator.
5. **Lo Limit Vacuum Switch:** If the vacuum in the ozone output supply line falls below 2 in. Hg the switch will open causing the system to shut-down.
6. **Ventilation Fan:** Cooling fan operates whenever the ozone generator is plugged in.
7. **Intake Screens:** Easily removable screens keep debris from entering the enclosure. *See Figure 3.*

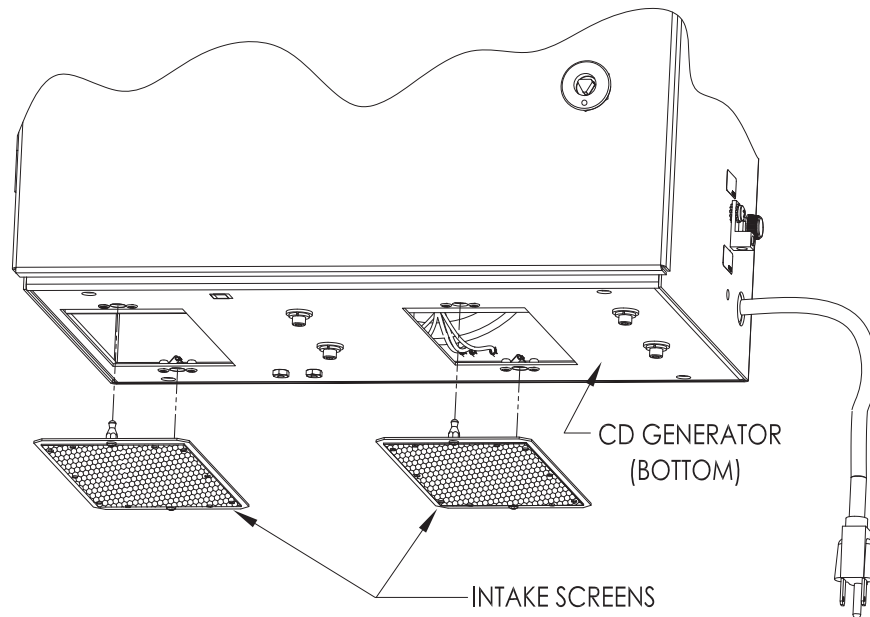

**Figure 3: Intake Screen Replacement**

#### 4B. Preventative Maintenance Schedule

The Genesis™ Corona Discharge ozone system requires very little maintenance beyond general housekeeping practices.

##### DAILY:

1. Check ozone generator for proper operation.
2. Make sure red indicator light is not illuminated.
3. Make sure flow meter is indicating proper air flow.

##### MONTHLY:

1. Clean intake screens.
2. Perform general cleaning of cabinet interior.
3. Visually inspect compressor filter element.  
Replace as required.
4. Visual inspection of all plumbing, mechanical, and wiring in system.

##### ANNUALLY:

1. Replace/oxygen supply line check valve.
2. Replace oxygen supply line check valve.
3. Verify oxygen output.

##### EVERY 8,750 HOURS:

1. Rebuild air compressor.

#### 4C. Troubleshooting

Knowledge of electrical applications is required for troubleshooting. Contact a certified electrician if you are unsure of your ability to service the equipment. Improper servicing will void generator

warranty. If any condition persists, call 1-800-676-1335 for technical assistance.

**Symptom:** “POWER” light out when system plugged in and door is closed.

1. No power to the generator:
  - a. Check the circuit breaker at the facility power distribution box.
  - b. Check for loose connections or wiring breaks from the power distribution box to the generator.

**Symptom:** “OZONE” indicator light out.

1. Ozone power fuse is bad.
  - a. Check fuse and replace if necessary.
2. Loss of vacuum.
  - a. Check red vacuum indicator light. If light is on refer to corresponding symptom and corrective action below.
3. Ozone cell high temperature.
  - a. Check operation of ventilation fan.
  - b. Check intake screens for obstruction of air flow.

**Symptom:** “VACUUM” indicator light is on indicating out of range vacuum being supplied.

1. Injector not supplying adequate suction.
  - a. Check pump and ensure water is flowing through injector.
  - b. Check by-pass valve and adjust if necessary to obtain proper pressure differential in order to re-establish suction.

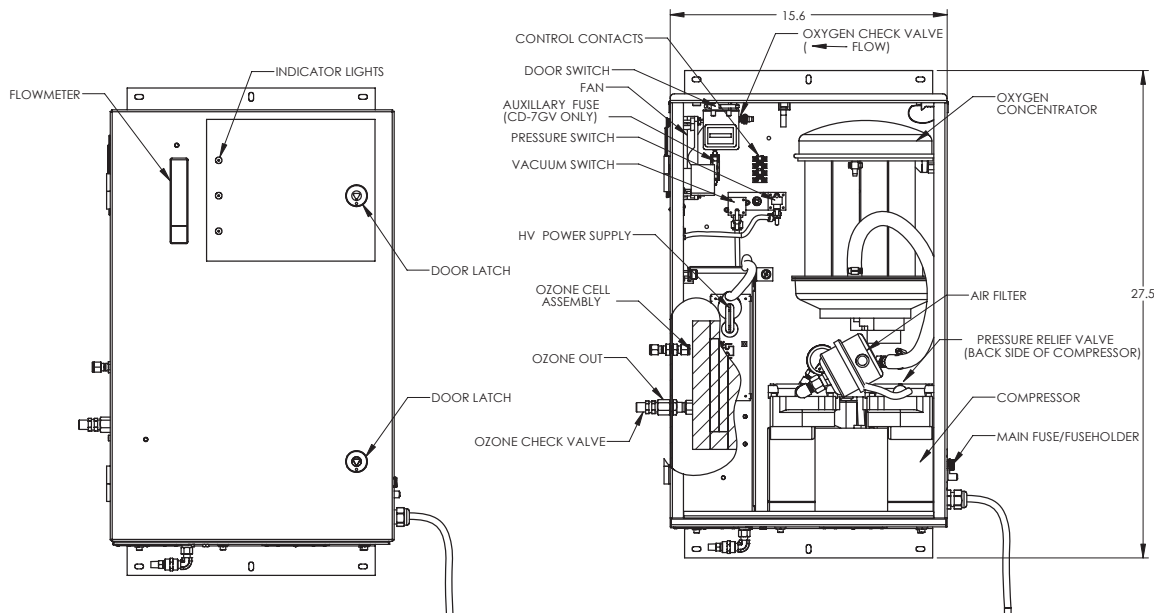

**Figure 4: Component Locations**

**Symptom:** CD Module is not operating. Ozone output has dropped.

1. No power to the generator module from the power supply:
  - a. Check fuse(s).
  - b. Check H.V. cables for breaks or loose connections, replace if necessary.
  - c. Check for power at input terminals of the H.V. power supply.\*

\* **CAUTION: HIGH VOLTAGE.**

**Symptom:** No air flow through the generator. The air flow meter indicates 0 scfh flow.

1. Injector not set properly.
  - a. Adjust injector by-pass valve until proper air flow is indicated.
2. Air compressor is not operating properly.
  - a. Listen for air compressor operation.
  - b. Check all tubing connections from the air compressor through the system for leaks.
3. Ozone supply tubing damaged.
  - a. Check tubing for blockage or kinks.
  - b. Check for loose or damaged fittings.

## 4D. Contact Information

**For Technical assistance:**

Call: 1-800-676-1335 ext. 293

Email: [service@delozone.com](mailto:service@delozone.com)

Visit: [www.delozone.com](http://www.delozone.com)

## SECTION 5 Replacement Parts & Order Information

### 5A. Ordering information

For replacement parts call DEL at 1-800-676-1335. Be prepared with the following information:

- Customer Name
- Customer Address
- DEL Model Number
- DEL Serial Number
- Date Purchased
- Proof of Purchase

## DEL OZONE COMMERCIAL PRODUCT LIMITED TWO YEAR WARRANTY

The limited warranty set forth below applies to products manufactured by DEL OZONE – 3580 Sueldo Street, San Luis Obispo, California 93401, and sold by DEL OZONE or its authorized dealers. This limited warranty is given only to the first retail purchaser of such products and is not transferable to any subsequent owners or purchasers of such products. Systems sized 65 grams or greater require factory commissioning and startup to maintain warranty as set forth below.

DEL OZONE warrants that DEL or DEL authorized dealers will repair or replace, at DEL's option, any part of such products proven to be defective in materials or workmanship within two (2) years of the date of receipt. Parts are covered under the two (2) year warranty when and only when the stated maintenance requirements are met. Contact tanks and degas valves have a ninety (90) day warranty. Compressor(s) must be maintained per operation and maintenance manual. Required maintenance includes a compressor rebuild after one (1) year or every 8,760 hours, which ever is reached first. Warranty does not include parts for compressor(s) rebuild kit(s), or other consumable items. See owner's manual for complete maintenance details. This Warranty specifically excludes any components not manufactured by DEL OZONE that are external to the products covered, such as pumps, air compressors, monitors, tanks, or related components. DEL OZONE will assist with warranty claims for such components purchased through DEL OZONE; limited to the extent of the manufacturer's standard warranty. ANY REPAIR OR REPLACEMENT WILL BE WARRANTED ONLY FOR THE BALANCE OF THE ORIGINAL TWO (2) YEAR WARRANTY PERIOD

**NOTE: USE ONLY DEL AUTHORIZED DEL REPLACEMENT PARTS. USE OF ANY OTHER PART(S) WILL VOID THIS WARRANTY.**

***Any replaced parts must be returned to DEL OZONE for warranty evaluation.***

**THIS LIMITED WARRANTY DOES NOT INCLUDE ANY OF THE FOLLOWING:**

- (a) Any labor charges for troubleshooting, removal, or installation of such parts.
- (b) Any repair or replacement of such parts necessitated by faulty installation, improper maintenance, improper operation, misuse, abuse, negligence, accident, fire, flood, repair materials, and/or unauthorized accessories.
- (c) Any such products installed without regard to required local codes and accepted trade practices.
- (d) Damage to unit caused by water backflow;
- (e) Any implied warranty of merchantability or implied warranty of fitness for particular purpose, and such warranties are hereby disclaimed.
- (f) DEL Ozone shall not be liable under any circumstances for loss of use of such product, loss of profits, direct damages, indirect damages, consequential damages, and / or incidental damages.

This warranty gives you specific legal rights. You may have other rights which vary from state to state.

**Extended Warranties and Service Agreements are available. Contact DEL for additional details.**

**TO OBTAIN WARRANTY SERVICE:**

DEL OZONE  
3580 Sueldo, San Luis Obispo, CA 93401  
Customer Service Number: (800) 676-1335  
Fax Number: (805) 541-8459  
E mail: [service@delozone.com](mailto:service@delozone.com)

**PROVIDE:**

- 1. Project, contact name, mailing address and telephone.**
- 2. Installer/Mechanical Contractor.**
- 3. Unit Part Number, Serial Number, and date of purchase.**
- 4. The date of failure.**
- 5. A description of the failure.**

After this information is provided, DEL Ozone may release a *RETURN GOODS AUTHORIZATION (RGA) NUMBER*. After receiving the RGA number the part in question must be returned to DEL Ozone, freight prepaid, with the RGA number clearly marked on the outside of the package. All preauthorized defective parts must be returned to DEL Ozone within thirty (30) days. Under no circumstances may any product be returned to DEL Ozone without prior authorization. Returns without the assigned RGA number on the outside of the package will be refused and shipped back to the sender at their expense. Upon receipt of preauthorized returned goods, DEL Ozone will repair or replace, at DEL Ozone's option, the defective product(s) and return them (freight prepaid for products under warranty). Buyer's acceptance of the product and use thereof constitutes acceptance of these terms.



# **APPENDIX “A” SAFETY**

# OZONE

## Material Safety Data Sheet

NFPA 704 Designation  
Hazard Rating

4 = Extreme  
3 = High  
2 = Moderate  
1 = Slight  
0 = Insignificant

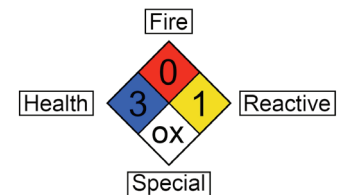

### SECTION I: MATERIAL IDENTIFICATION

<b>IDENTITY:</b> OZONE (Gaseous)	<b>ISSUED:</b> February, 1992
<b>FORMULA:</b> O <sub>3</sub>	<b>REVISED:</b> May 12, 2014
<p><b>Description (origin/uses):</b> Occurs in atmosphere from UV light action on oxygen at high altitude. Commercially obtained by passing air between electrodes carrying a high voltage alternating current. Also found as a by-product in welding areas, high voltage equipment, or UV radiation.</p> <p>Ozone is used as an oxidizing agent in air and water disinfection: for bleaching textiles, oils, and waxes; organic synthesis as in processing certain perfumes, vanillin, camphor; for mold and bacteria control in cold storage.</p>	
<p><b>Cautions:</b> A powerful oxidizing agent, ozone generally exists as a gas and is highly chemically reactive. Inhalation produces various degrees of respiratory effects from irritation to pulmonary edema (fluid in lungs) as well as affecting the eyes, blood, and central nervous system.</p>	
<p><b>Manufacturer/Supplier:</b> On-site generation, equipment available from various suppliers, including:            DEL Ozone Phone: (805) 541-1601            3580 Sueldo Street FAX: (805) 541-8459            San Luis Obispo, CA 93401</p>	

### SECTION II: INGREDIENTS AND HAZARDS

<b>Ozone, CAS No. 10028-15-6: NIOSH RTECS No. RS8225000</b>	
1991 OSHA PELs 8-hr TWA: 0.1 ppm vol. (0.2 mg/m <sup>3</sup> ) 15-min STEL: 0.3 ppm vol (0.6 mg/m <sup>3</sup> )	1991-1992 ACGIH TLV Ceiling: 0.1 ppm (0.2 mg/m <sup>3</sup> )
1990 IDLH 10 ppm	1990 DFG (Germany) MAK TWA: 0.1 ppm (0.2 mg/m <sup>3</sup> ) Category 1: Local Irritant Peak Exposure Limit: 0.2 ppm 5 min momentary value, 8 per shift
1990 NIOSH REL Ceiling: 0.1 ppm vol. (0.2 mg/m <sup>3</sup> )	
<b>Other Designations:</b> Triatomic oxygen: CAS No. 10028-15-6, NIOSH RTECS No. RS8225000	

### SECTION III: PHYSICAL DATA

<b>Boiling Point:</b> . . . . . -169° F	<b>Melting Point:</b> . . . . . -315.4° F (-193° C)
<b>Vapor Pressure:</b> . . . . . >1 ATM	<b>% Volatile by Volume:</b> . . . . . 100%
<b>Vapor Density (AIR = 1):</b> . . . . . 1.6	<b>Molecular Weight:</b> . . . . . 48 Grams/Mole
<b>Solubility in Water:</b> . . . . . 0.49 ml @ 32° F (0° C), 3 ppm @ 20° C	<b>pH:</b> . . . . . Not Listed
	<b>Critical Temperature:</b> . . . . . 10.22° F (-12.1° C)

**Appearance and Odor:** Colorless to blue gas (greater than -169° F): characteristic odor often associated with electrical sparks or lightning in concentrations of less than 2 ppm and becomes disagreeable above 1-2 ppm. CAUTION: Olfactory fatigue develops rapidly, so do not use odor as a preventative warning device.

### SECTION IV: FIRE AND EXPLOSION HAZARD DATA

<b>Flash Point:</b> . . . . . Nonflammable
<b>Extinguishing Media:</b> . . . . . Use large amounts of water spray or fog to put out fires involving ozone. Use appropriate fire-fighting techniques to deal with surrounding material.
<b>Special Fire Fighting Procedures:</b> . . . . . Wear a self contained breathing apparatus with full face pieces operated in a pressure-demand or other positive-pressure mode.
<b>Unusual Fire/Explosion Hazards:</b> . . . . . Decomposition of ozone into oxygen gas, (O <sub>2</sub> ), can increase strength of fire.

### SECTION V: REACTIVITY DATA

**Stability:** Ozone is not stable. Hazardous polymerization cannot occur.

**Chemical Incompatibilities:** Ozone is chemically incompatible with all oxidizable materials, both organic and inorganic.

**Conditions to Avoid:** Ozone is unstable at room temperatures and spontaneously decomposes to oxygen gas. Avoid ignition sources such as heat, sparks, and open flame. Keep away from strong reducing agents and combustible materials such as grease, oils, and fats.

**Products of Hazardous Decomposition:** Ozone spontaneously decomposes to oxygen gas, even at room temperatures.

## SECTION VI: HEALTH HAZARD DATA

**Carcinogenicity:** Ozone is not listed as a carcinogen by the NTP, IARC, or OSHA.

**Primary Entry:** Inhalation

**Target Organs:** Respiratory system, eyes, blood.

**Summary of Risks:** There is no true threshold limit and so no exposure (regardless of how small) is theoretically without effect from ozone's strong oxidative ability. Ozone passes straight to the smallest bronchioles and alveoli and is not absorbed by mucous membranes along the way. Initial small exposure may reduce cell sensitivity and/or increase mucous thickness producing a resistance to low ozone levels. Short exposure to 1-2 ppm concentrations causes headache as well as irritation to the respiratory tract, but symptoms subside when exposure ends. High concentrations of ozone produce severe irritation of the eyes and respiratory tract. Exposure above the ACGIH/OSHA limits produce nausea, chest pain, coughing, fatigue, reduced visual acuity, and pulmonary edema. Symptoms of edema from excessive exposure can be delayed one or more hours. Inhalation of >20 ppm for an hour or more (>50 ppm for 1/2 hour) can be fatal.

**Acute Effects:** Acute damage from ozone appears to be mainly from its oxidizing effect on contact with tissue.

**Chronic Effects:** Respiratory disease. Deleterious effects on lungs and acceleration of tumors have been reported.

**Medical Conditions Generally Aggravated by Long-Term Exposure:** History of respiratory or heart disorders.

**First Aid:** Remove from ozone containing air, get prompt medical help\*, administer oxygen if necessary.

**Eye Contact** - Gently lift eyelids and flush eyes continuously with flooding amounts of water for 15 minutes or until transported to a medical facility\*.

**Inhalation** - Remove exposed person to fresh air, support breathing, administer humidified oxygen as needed, get medical help\*.

**Ingestion** - Highly unlikely since ozone is a gas until -169° F,

\* **GET MEDICAL ASSISTANCE = APPROPRIATE IN-PLANT, PARAMEDIC, or COMMUNITY.** Get prompt medical assistance for further treatment, observation, and support after first aid.

## SECTION VII: PRECAUTIONS FOR SAFE HANDLING AND USE

**Steps to be Taken in Case of Spill/Leak:**

1. Discontinue production
2. Isolate and vent area
3. Immediately notify personnel
4. Deny entry
5. Follow applicable OSHA regulations

**Disposal:** Provide ventilation to dilute and disperse small amounts of ozone (below OSHA PELs) to outside atmosphere. Follow federal, state, and local regulations.

**Handling/Storage Precautions:** Ensure proper personnel training and establish emergency procedures.

## SECTION VIII: CONTROL MEASURES

**Respiratory Protection:** High Level (>10 ppm) - Self Contained Breathing Apparatus: MISH/NIOSH approved.

Low Level (0.3 - 10 ppm) - Canister Type (carbon) respirator may be used.

**Eye Protection:** Wear chemical safety goggles if necessary to work in high ozone (>10 ppm).

**Skin Protection:** Effects of ozone on skin are minimal to non-existent.

**Ventilation:** Provide general and local exhaust ventilation to dilute & disperse small amounts of ozone into outside atmosphere.

## SECTION IX: SPECIAL PRECAUTIONS AND COMMENTS

**Storage Segregation:** Prevent ozone from coming into direct physical contact with strong acids or bases or with strong oxidizing/reducing agents.

**Engineering Controls:** Install ventilation systems capable of maintaining ozone to concentrations below the ACGIH/OSHA exposure limits (see sect. II). Install ambient ozone monitor(s) configured to shut down ozone equipment and turn high speed ventilation on.

**Material Safety Data Sheet**

This MSDS complies with OSHA's Hazardous Communication Standard 29 CFR 1910.1200 and OSHA form 174.

**DEL Ozone**  
**3580 Sueldo Street**  
**San Luis Obispo, CA 93401**

Product Information 805-541-1601

NFPA 704 Designation  
 Hazard Rating

4 = Extreme  
 3 = High  
 2 = Moderate  
 1 = Slight  
 0 = Insignificant

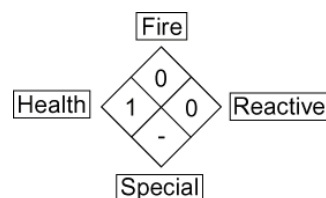

Product Name		<b>AQUEOUS OZONE SOLUTION</b>			
Chemical Name		DISSOLVED OZONE GAS IN WATER 0 TO 2 PPM			
Product Description		AQUEOUS SOLUTION OF OZONE DISSOLVED IN POTABLE WATER			
D.O.T. Shipping Classification		NON REGULATED			
<b>I PHYSICAL DATA</b>					
Boiling Point	212 F	Freezing Point	32 F		
Specific Gravity	1.0	Solubility in Water	COMPLETE		
Evaporation Rate	APPROX 1	Physical Form	LIQUID		
Appearance & Odor	COLORLESS (CLEAR) WATER WITH FRESH, ASEPTIC ODOR				
<b>II HAZARDOUS INGREDIENTS</b>					
MATERIAL	HAZARD	CAS #	% BY WT	ACGIH TLV	OSHA PEL
None					
<b>III FIRE AND EXPLOSION HAZARD DATA</b>					
Flash Point	NA	Method	NA	Auto Ign. Temp.	NA
Flammable Limits in Air	NON APPLICABLE		Lower	NA	Upper NA
Extinguishing Media	NON APPLICABLE				
Unusual Fire & Explosion Hazards	NONE				
Special Fire Fighting Procedures	NONE				

4-1444-01\_Rev.B

**Material Safety Data Sheet** Cont.Product Name **AQUEOUS OZONE SOLUTION**

<b>IV HEALTH HAZARD DATA</b>	
Threshold Limit Value	NOT DETERMINED
Route of Exposure	<input type="checkbox"/> Inhalation <input type="checkbox"/> Ingestion <input type="checkbox"/> Skin <input checked="" type="checkbox"/> Eye <input checked="" type="checkbox"/> Not Hazardous
Eye Contact Hazard	Exposure may cause mild eye irritation, but is not expected.
Ingestion Hazard	Not Hazardous
Inhalation Hazard	Inhalation is not likely to be a primary route of exposure but could become irritating if aerosols are exposed to individual for extended period of time.
Skin Contact Hazard	No skin irritation is expected from short term exposure.
Skin Absorption Hazard	No published data indicates this product is absorbed through the skin.
Effects of Acute Exposure	Mild skin or eye irritation.
Effects of Chronic Exposure	Repeated exposure of the skin to concentrated product should be avoided to prevent irritation and drying of the skin.
<b>V EMERGENCY AND FIRST AID PROCEDURES</b>	
Eye Contact	If exposure to water containing aqueous solution of ozone causes irritation to eyes, flush eyes with plenty of clean, ozone free, running water for at least 15 minutes, lifting the upper and lower lids occasionally. Remove contact lenses if worn. Seek medical attention if irritation persists.
Skin Contact	Not likely to become irritated unless repeatedly exposed to large volumes of material. If irritation develops, rinse affected area with ozone free potable water. If irritation continues seek medical advice.
Inhalation	Inhalation of mists could lead to irritation of lungs. If symptoms develop, move individual away from exposure and into fresh air. If symptoms persist, seek medical attention.
Ingestion	NA
<b>VI REACTIVITY DATA</b>	
Incompatibility (Materials to Avoid)	Natural rubber (may degrade, or "dry", rubber components over extended periods of exposure)
Conditions to Avoid	NONE KNOWN
Hazardous Decomposition	NONE
Stability	<input checked="" type="checkbox"/> STABLE <input type="checkbox"/> UNSTABLE   Hazardous Polymerization <input type="checkbox"/> MAY OCCUR <input checked="" type="checkbox"/> WILL NOT OCCUR

**Material Safety Data Sheet** Cont.Product Name **AQUEOUS OZONE SOLUTION**

<b>VII SPILL OR LEAK PROCEDURES</b>				
Steps To Be Taken If Material Is Released Or Spilled		NONE		
Waste Disposal Method		DISPOSE OF THE SAME AS POTABLE RINSE WATER		
<b>VIII SPECIAL PROTECTIVE INFORMATION</b>				
Respiratory Protection (Specify Type)		NOT REQUIRED FOR NORMAL USE OF THIS PRODUCT		
Ventilation	Local Exhaust	PREFERABLE	Special	NA
	Mechanical (general)	OK	Other	NA
Protective Gloves	NOT REQUIRED			
Eye Protection	NOT REQUIRED			
Other Protective Equipment	NOT REQUIRED			
<b>IX SPECIAL PRECAUTIONS</b>				
Precautionary Labeling	Certified testing of DEL Ozone systems by NSF (National Sanitation Foundation) has shown that under normal conditions of use, aqueous solutions containing low levels of ozone gas dissolved in potable water do not present a safety hazard when contact to the individual is incidental. When used in a room with normal ventilation, levels of ozone gas being released into the air have been shown by NSF to be well below the periodic exposure levels established by OSHA for worker safety through the use of DEL's ozone management technology.			
Precautions To Be Taken In Handling	Aqueous solutions of ozone in potable water should not be sprayed as an aerosol (i.e. >20psi) to avoid releasing higher levels of ozone gas into the work area. The decay rate of ozone gas is a function of temperature and exposure to organic material. Certified testing has shown that when ozone gas has been properly dissolved in ambient temperature (or colder (33 – 70 °F)) potable water at a level not exceeding 2 mg/l (ppm) using DEL's ozone management technology, the rate at which ozone is released from the water as ozone gas is below the PEL established for gaseous ozone.			
Rev. Date 03/26/09				
This material safety data sheet is provided as an information resource only. It should not be taken as a warranty or representation for which the preparer assumes legal responsibility. While we believe the information contained herein is accurate and compiled from sources believed to be reliable, it is the responsibility of the user to investigate and verify its validity. The buyer assumes all responsibility of using and handling the product in accordance with applicable federal, state, and local regulations.				





3580 Sueldo Street, San Luis Obispo, CA 93401 | 800.676.1335 | o3info@delozone.com | [www.delozone.com](http://www.delozone.com)  
EPA Estab. No. 071472-CA-001